

AXIOMTM LITE

USER MANUAL



TRUE PERFORMANCE, ABSOLUTE QUALITY.

Contents

Quick Start Steps.....	3	Backlight and Speed.....	16
Contents.....	4	Sensitivity	17
Assembly.....	5	Ground Balance Procedure/Indicators.....	18
Controls	6	Ground Balance Window and Hot Rocks	18
LCD/Display Elements.....	7	Ground Track	20
Battery Info/Software Upgrades	8	Iron Check.....	21
Z-Lynk Wireless Operation	10	Detecting Tips and Techniques	22
Functions and Settings	11	Bench Tests.....	23
Factory Reset.....	11	General Advice.....	24
Frequency Scan.....	11	Troubleshooting.....	25
Detection Modes.....	12	Warranty / Regulatory Info	26
Fine, Normal, Large, Salt	12	<i>Axiom</i> Specifications.....	27
Volume and Threshold Adjustment.....	13		
Tone and Audio Options.....	14		
Target Signal Strength Indicators	15		



Quick Start Steps

This page provides the basic procedures needed to begin detecting with your Garrett Axiom.

1. Power ON.

Press and release the ON / OFF Power button.

1, 2

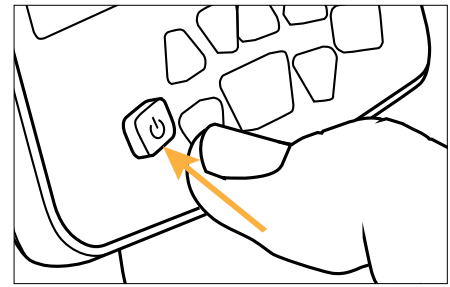

2. Set Sensitivity, Threshold and Volume

to preferred levels.

Note: Axiom is an extremely sensitive detector. Please refer to the "Sensitivity" section for advice on urban operation and using high sensitivity settings.

3. Perform Frequency Scan (if needed to eliminate electrical interference).

Press MENU button until FREQ SCAN is selected, then press the MENU plus (+) button to begin process. Takes approximately 45 seconds.

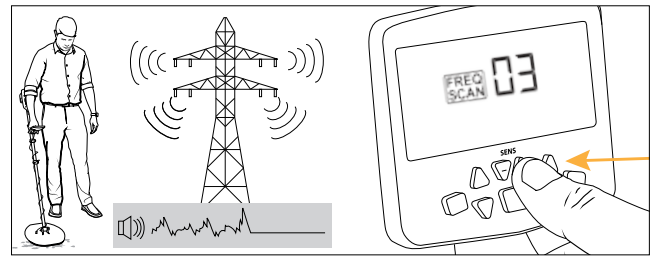

3

4. Ground Balance (if needed to eliminate ground response).

Press and hold GND BAL button while bouncing coil above the ground until ground response disappears or becomes as small as possible.

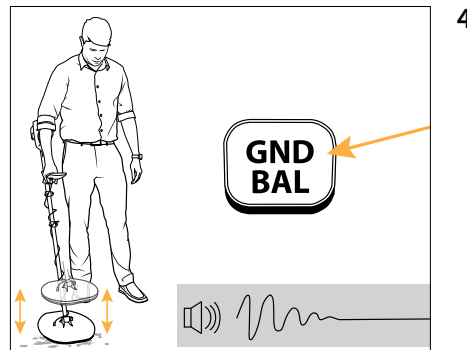

4

5. Begin scanning.

Lower the searchcoil to about one-half inch (1.25 cm) above the ground and scan the coil left and right at approximately 3 feet/second (1 meter/second). The coil must be in motion for target detection.

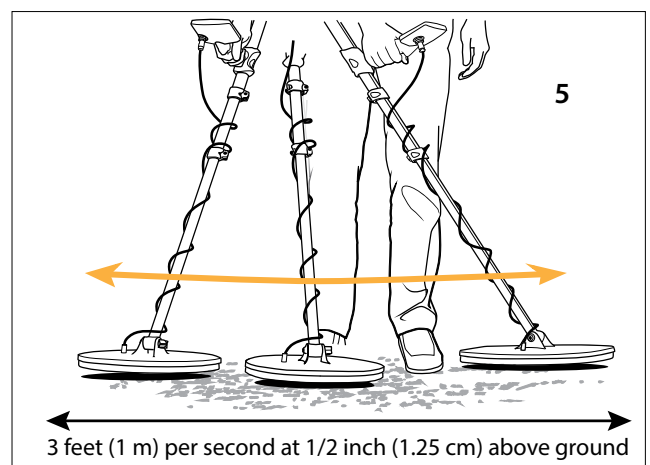

5

FACTORY RESET (if desired)

All settings are saved at Power OFF. Perform a Factory Reset to return the unit to its factory settings by holding down the Power button for five (5) seconds until a double-beep is heard.

Factory settings are:

Sensitivity:	4
Volume:	25
Threshold:	15
Mode:	Fine
Frequency:	50
Tone:	50
Audio:	01(VCO)
Ground Balance:	49/49
Wireless:	Off
Backlight:	Off
Speed:	Medium
Ground Track:	Off

Axiom Carton Contents

The Axiom is packaged with the following parts, some partially assembled. If any part is missing, please contact Garrett Customer Service.



Stem assembly with mounted control box

Upper and lower stem



Searchcoil with coil cover installed



Warranty card

Soft carry case



Bolt, mounting washers



Wall charger and adaptors



USB-C charging cable

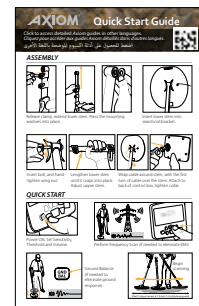

Quick-Start Guide

Note: Full Axiom user's manual is available on garrett.com in multiple languages



Assembly and Adjustments

Extend shaft, insert washers

1. Release lower stem clamp.
2. Extend lower stem.
3. Press mounting washers into place.

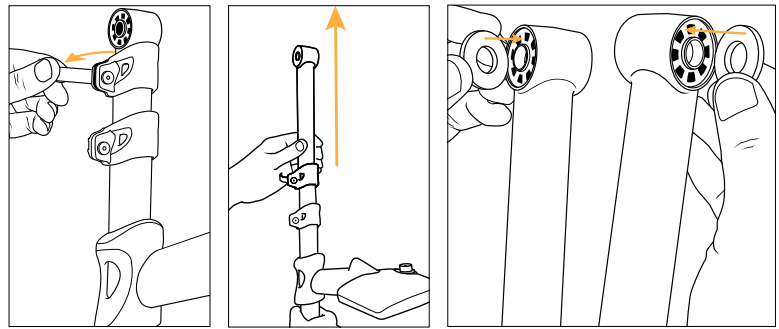

Attach the searchcoil

4. Insert lower stem assembly into searchcoil bracket.
5. Insert bolt in direction shown, and lightly hand-tighten bolt.

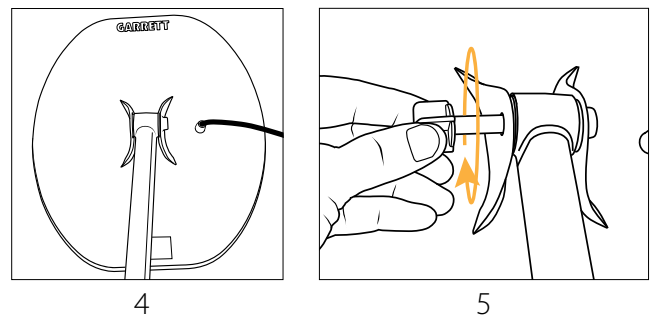

Connect the searchcoil

6. Fully lengthen lower stem until it snaps into place; then adjust upper stem to comfortable length, and close stem clamps.
7. Wrap cable snugly around stem with first turn of cable over the stem.
8. Insert coil connector into back of control box, making sure to properly line up connectors, and tighten collar.

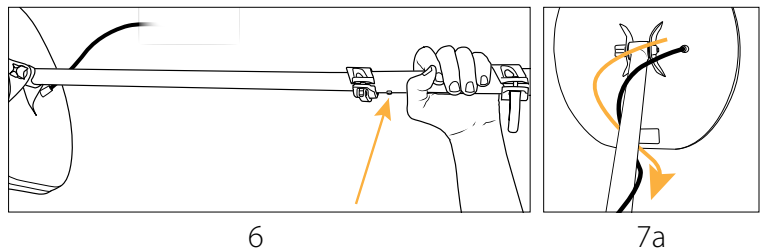

Adjusting arm cuff (if desired)

9. Use the hex wrench (stored below the cuff) to remove all four screws within the arm cuff.
10. Cuff can be moved as many as two slots forward or two slots backward. (At least two bolts must be secured through the cuff for stability.)
11. Reinsert all four screws and tighten.

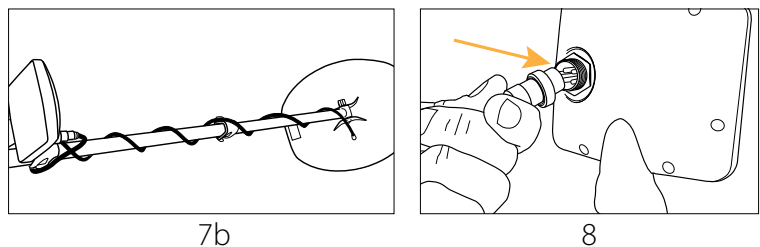

Adjusting stem clamp screws

Your *Axiom's* stem clamp screws may occasionally need to be slightly tightened with the included hex wrench. *Caution:* over-tightening of the stem clamp screws may result in damaged or broken clamps.

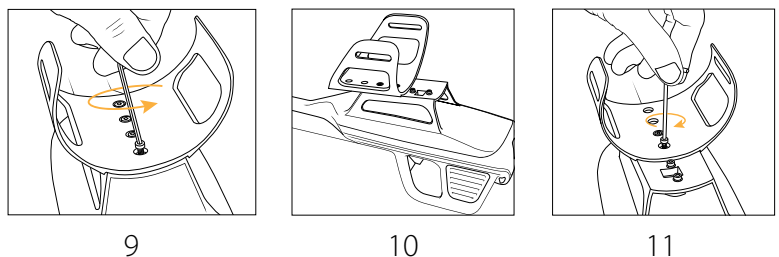

Caution: Always power OFF your Axiom before changing searchcoils. Disconnecting and reconnecting coils while the detector is powered on could damage the searchcoil and/or the detector's electronics.

Controls

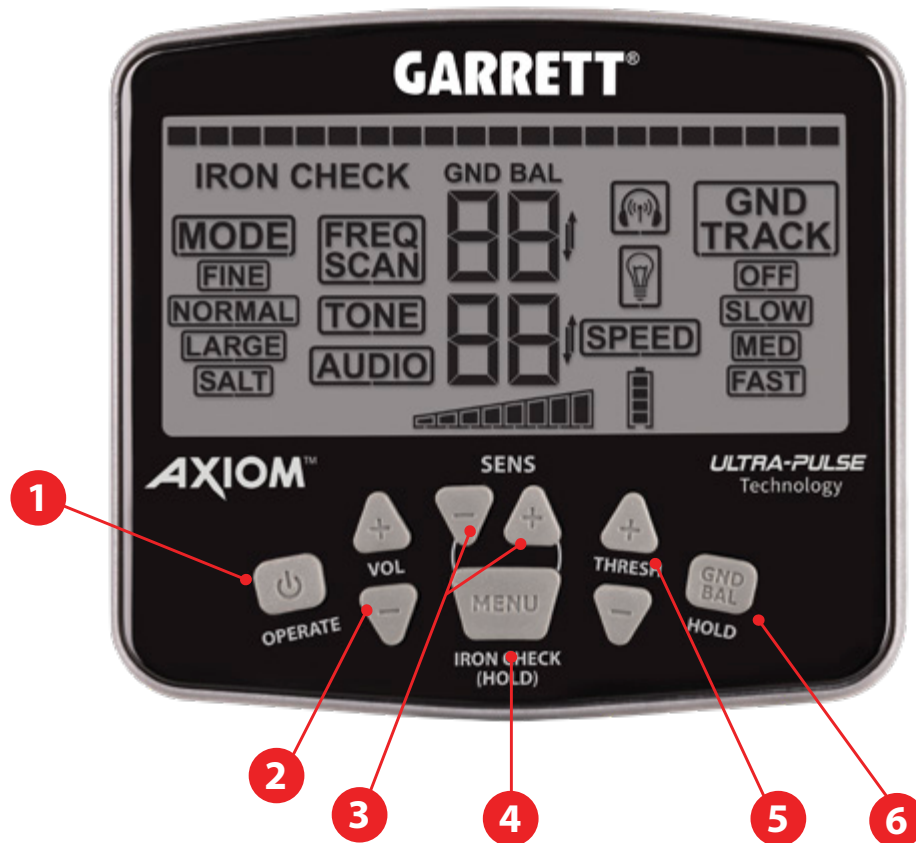

Note: Use the Plus (+) or Minus (-) above the Menu button to adjust any of the Menu options. Axiom automatically exits the Menu settings after 20 seconds with no activity; or, simply press the OPERATE button at any time to exit the Menu.

- 1. Power ON/OFF and OPERATE**—Hold for one second to turn power ON or OFF. Press and hold for five seconds to restore Factory Settings. Tap to exit MENU settings.
- 2. VOLUME Plus/Minus buttons**—Use to increase or decrease detector volume.
- 3. SENSITIVITY Plus/Minus buttons**—Use to increase or decrease Sensitivity setting. While adjusting MENU settings, these Plus/Minus buttons are also used to alter detector settings.
- 4. MENU/Iron Check**—Repeatedly press to scroll through menu items, then press the Plus (+) or Minus (-) buttons directly above the Menu button to change setting. Press and hold this button to utilize the Iron Check function (see page 21).
- 5. THRESHOLD Plus/Minus**—Use to increase or decrease the background audio hum that is added to the target response.
- 6. Ground Balance**—Hold the GND BAL button while bouncing coil above the ground until ground response disappears or becomes as small as possible.



LCD/Display Elements

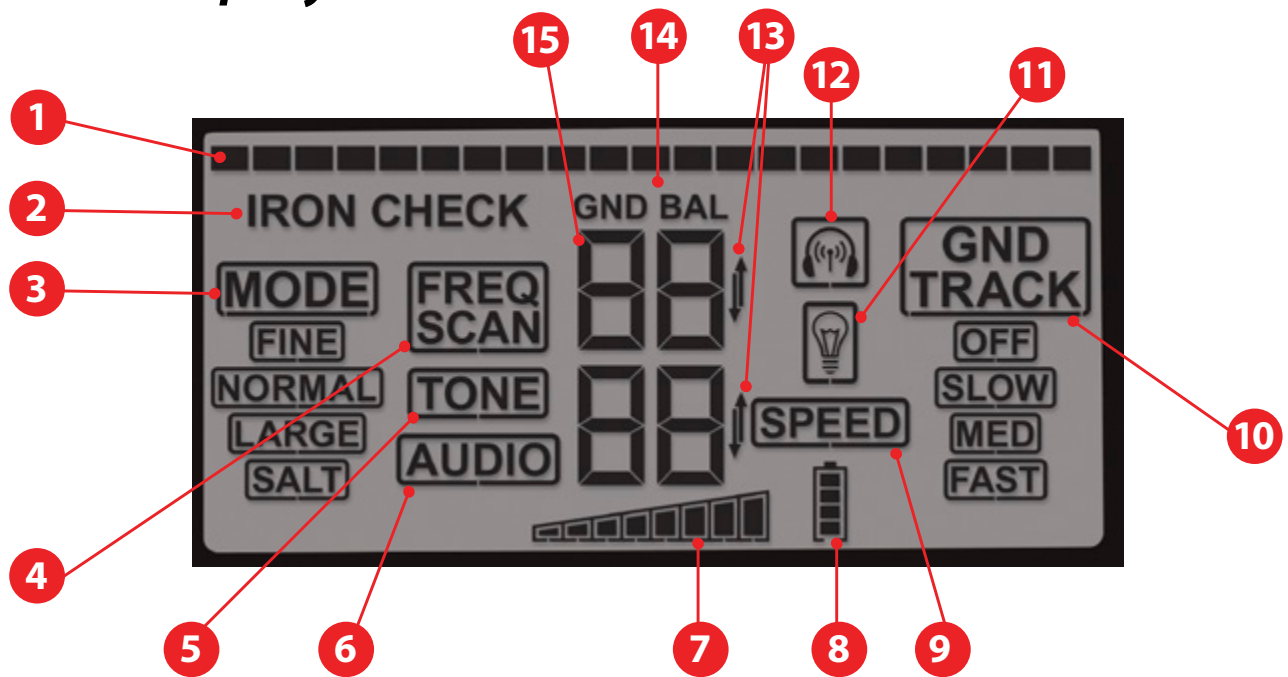

- 1. Signal Strength Indicator**—directional bar graphs indicates both signal strength and polarity (i.e. high tones to the right; low tones to the left).
- 2. Iron Check**—Indicates that *Axiom's* Iron Check feature is in use (see page 19).
- 3. Mode**—Indicates which detection mode is currently selected. Select from Fine, Normal, Large or Salt.
- 4. Frequency Scan**—Use to automatically select the quietest detecting frequency when audio response is erratic due to EMI. When FREQ SCAN is highlighted, press Plus (+) Menu button to begin the scan or Minus (-) button to exit the scan. Takes approximately 45 seconds.
- 5. Tone**—Scroll through 00 to 99 to select your preferred audio tone.
- 6. Audio Type**—Select 0 for PWM audio or 01 for VCO audio (see page 14).
- 7. Sensitivity**—Indicates current Sensitivity setting.
- 8. Battery Level**—Shows status of battery life (25% per segment). Recharge battery when one segment remains.
- 9. Speed**—Select Slow, Medium or Fast detection speed (see page 17).
- 10. Ground Track**—Select Off, Slow, Medium or Fast continuous ground tracking speeds (see page 22).
- 11. Backlight**—Indicates LCD Backlight is on.
- 12. Wireless headphones**—Wireless icon flashes while attempting to pair. Wireless icon is solid when unit is paired with headphones.
- 13. Ground Balance Arrows**—Indicates the trending direction of ground balance when Gnd Track is on.
- 14. Ground Balance Indicator**—Displays while performing ground balance.
- 15. Ground Balance Values**—are shown by the upper and lower 2-digit numbers.

Battery Information

Basic Information

- Battery Type: Internal Lithium-Ion
- Battery Life: 16 hrs typical, depending on settings
- Battery Scale: 25% per pixel, bottom pixel flashes at 5% remaining
- Recharge Time: 7 to 8 hours from supplied 3-amp USB wall charger or comparable USB port (with detector OFF, longer if ON). Charge times will increase with lower-rated chargers.
- Charging Status: Flashing while charging, solid when charged
- Battery Life Cycle: Batteries will last for many years. Recharge prior to extended storage and at least once a year. If needed, the battery can be replaced at any certified Garrett service center.

Axiom Booster Pack - optional accessory

In the event of a depleted battery, *Axiom* can be operated with a booster pack. This pack will not recharge the *Axiom* internal battery and is only functional when *Axiom*'s internal battery is completely discharged. Expect 6 to 8 hours of operation from quality AA batteries.

- 1) Install eight (8) AA alkaline or NiMH batteries (see illustrations).
- 2) Clip the pack into the stand below the cuff, it click as it locks into place.
- 3) Plug in the USB connector.
- 4) Press button on side of pack to view pack's battery level. The pack's battery level will also temporarily show when pack is connected to the *Axiom* or when *Axiom* is switched on.

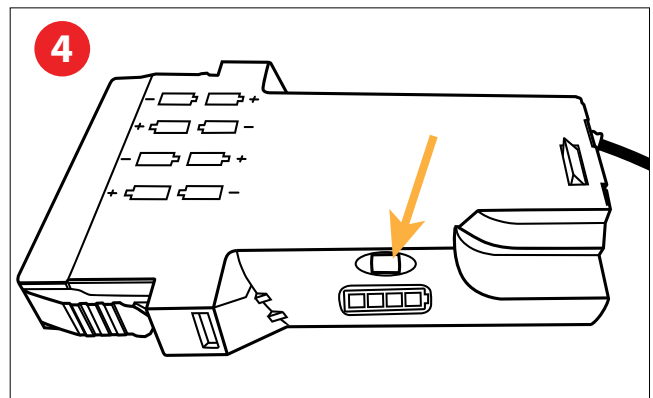
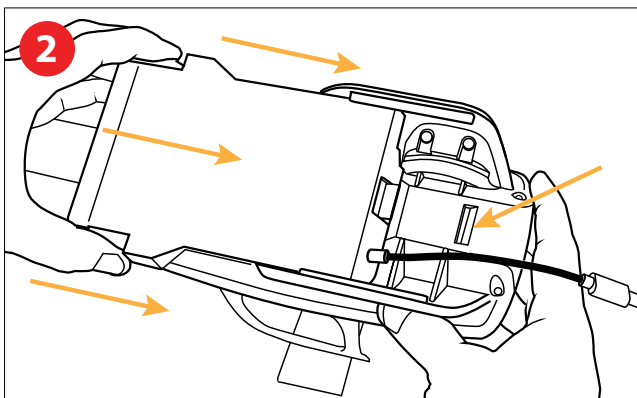
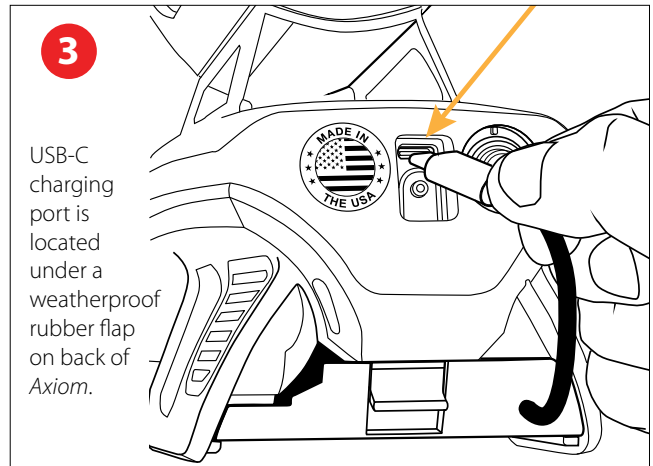
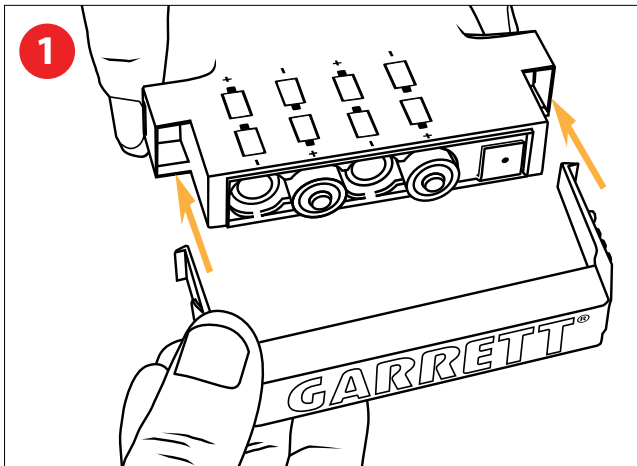

Battery Information *(continued)*

Detecting / Recharging with other USB Power Bank

A standard 5-volt USB power bank can be used to power the *Axiom* and/or to recharge its internal battery. A power bank with a 3-amp capacity will provide the fastest charge.

Charging From 12V Battery Terminals *(optional)*

Attach the black negative (-) clip to the negative (-) battery terminal, and the red positive (+) clip to the positive (+) battery terminal. Plug the charging connector into the USB-C port on the rear of the *Axiom*. Charge time is approximately 10 hours.

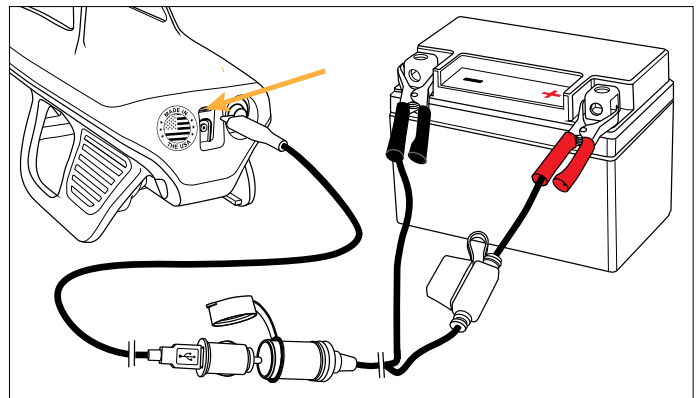

Axiom Software Upgrades

To update your *Axiom* to the latest software version available from Garrett, a PC computer running with Windows 7 or newer operating system or Mac OS 10.13 and higher is required. Visit garrett.com to become a free registered user in order to access any software updates.

These upgrades simply require connecting your *Axiom* to the computer via the detector's supplied USB charging cable and installing the Garrett Updater. Please visit garrett.com for detailed steps on updating your detector and to find the latest *Axiom* operating software version that is available.

Z-Lynk Wireless Operation

MS-3 wireless headphones not included with Axiom Lite detector.

Axiom features a built-in Z-Lynk wireless transmitter which can be used with Garrett MS-3 wireless headphones and any Z-Lynk enabled devices (such as any other headphones connected to a Z-Lynk receiver).

A Z-Lynk Wireless headphone icon (see illustration) on the LCD indicates the current status of your wireless connection. A steady icon indicates the detector is paired with an operating Z-Lynk receiver that is within range. A flashing icon indicates that the detector is searching for a receiver. Absence of the icon indicates that Axiom's wireless transmitter is switched off.

Pairing: To pair with a new set of headphones/receiver, simply switch the headphone/receiver on, hold within 2 feet (0.6 meters) of the Axiom. Next, power on Axiom. Repeatedly press the MENU button until the wireless icon is highlighted (as indicated in this illustration). Press the (+) button to pair the headphones.

Once paired, if the headphone/receiver is switched off or moved out of range, Axiom will search and attempt to reconnect to the receiver for 5 minutes, indicated by a flashing icon. If the connection is not reestablished during this time, Axiom will switch off its wireless transmitter. To reconnect, simply switch the Axiom off and then on again.

To unpair (forget) a set of headphones, simply press the MENU button to select the wireless icon and then use the (-) button to unpair.

Use of optional wired headphones: Axiom can also be operated with any wired headphones that have a 1/4" plug. For headphones with an 1/8" plug, an optional adaptor is available from Garrett.



Press MENU until the wireless icon is selected. Use Plus (+) or Minus (-) button to pair or unpair headphones.



Note: Optional MS-3 headphones include a user's guide for full details on wireless headphone operation. Sold separately.



Functions and Settings

Your *Axiom* is a highly sensitive pulse induction detector engineered for ease of operation. Each of its specific settings and functions are fully described in the pages which follow.

Factory Reset

Any changes made to *Axiom* settings are saved when the unit is switched off. To return all settings back to the original Factory values, press and hold the Power button for five (5) seconds. *Axiom* will produce a double beep to indicate that Factory Reset is complete.

Factory settings are:

Sensitivity:	4
Volume:	25
Threshold:	15
Mode:	Fine
Frequency:	50
Tone:	50
Audio:	01(VCO)
Gnd Balance:	49/49
Wireless:	Off
Backlight:	Off
Speed:	Medium
Ground Track:	Off

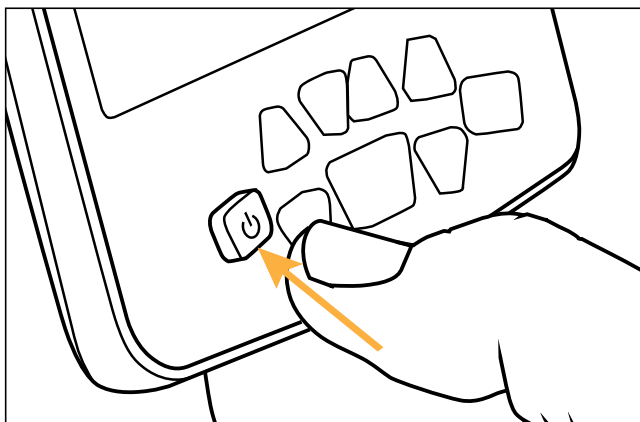

For Factory Reset, press and hold for 5 seconds, until a double-beep occurs.

Frequency Scan

Use this function to obtain the quietest operating frequency. Audio responses can become erratic at times due to sources of electromagnetic interference (EMI). Operating near power lines, other detectors, or anywhere indoors are some common examples of where EMI can be encountered.

To check for EMI, hold the *Axiom* searchcoil completely stationary away from any metal. If the detector remains noisy then it is caused by EMI.

To perform a Frequency Scan:

- Hold searchcoil stationary away from any metal.
- Press MENU button until FREQ SCAN is highlighted.
- Use the MENU plus (+) button to begin process.
- *Axiom* will scan through 100 frequencies, recheck the best 5, and then automatically pick the best frequency. Completion is indicated by a double beep.
- Takes approximately 45 seconds.

Note: If you have accidentally activated the Frequency Scan function and wish to exit this process, press the Minus (-) button to stop the function. The setting will return to its previous value.

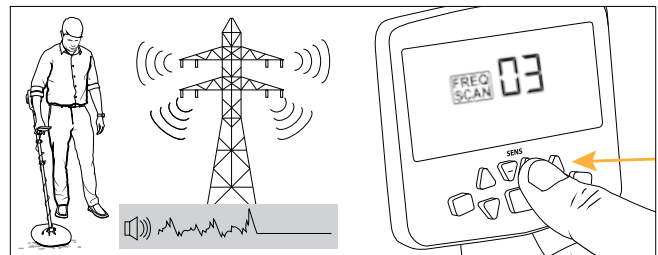

Detection Modes

The *Axiom* has four Search Mode options: Fine, Normal, Large and Salt. Each Search Mode is optimized for specific types of detecting, as detailed below. The Factory Default mode is Fine.

Press MENU button until MODE is selected, then use the Menu Plus (+) or (-) button to select the desired mode. Press Operate to exit the MENU, or press MENU to proceed to next menu item.

FINE Mode

Provides the maximum possible detection on small, low-conductivity targets (such as fine gold and specimen gold) while also providing the best detection of most medium and large targets. Because of its increased sensitivity to small/fine targets, FINE Mode can be more susceptible to ground minerals, hot rocks or saltwater. FINE is typically the preferred mode for most conditions.

NORMAL Mode

Provides very good detection on all size targets. NORMAL will be less reactive in highly mineralized soil but will have reduced detection of very small targets.

LARGE Mode

Maintains strong detection of large targets while reducing small and medium targets. Most important, this mode reduces susceptibility to highly mineralized ground and hot rocks.

SALT Mode

Designed for use in mineralized areas with wet salt content, primarily for wet saltwater beaches. SALT Mode may also be useful for salt beds and goldfields with high salt concentration, depending on moisture content. But it is recommended to first try the other modes for these inland conditions.



Press MENU to highlight MODE, then use Plus (+) or Minus (-) button to select the desired Mode. Only the selected Mode will remain on the LCD when the Menu is exited.



Volume and Threshold Adjustment

Volume Control

Use the Volume Plus (+) or Minus (-) buttons to adjust the maximum audio level produced by a large signal. This does not affect the audio level or sensitivity of a faint signal (i.e. Volume is a “limiter” and not a gain control). *Axiom* Volume is adjustable between 0 (no audio output) and 25. The default setting is 25.

Threshold

Use the Threshold Plus (+) or Minus (-) buttons to adjust the Threshold—the constant audio background “hum” that is added to the target response. *Axiom* Threshold is adjustable between -9 and 25. The default setting is 15.

It is recommended the Threshold be set to a barely audible level, or just below, based on hearing ability, surrounding audio conditions, and the *Axiom*'s background EMI noise level. Faint targets may only create a small variation in the audio; therefore running with a *high* Threshold level may obscure such faint signals. Setting the Threshold level too *low* may prevent faint signals from being heard. Readjust the audio Threshold level as conditions change (i.e. strong winds, surf noise, etc.) that affect your ability to hear the background hum at a barely audible level.

Note: In noisy EMI conditions, it may be necessary to use a negative Threshold setting to obtain desired audible threshold level.



Plus / Minus buttons for Volume adjustment

Plus / Minus buttons for Threshold adjustment

Tone and Audio Options

The *Axiom* provides the user with the ability to change the pitch of audio tones and to select from two distinctly different audio types.

Tone Adjustment

Press the MENU button until TONE is selected, then press the MENU Plus (+) or Minus (-) buttons to scroll through 100 available tone shifts.

Each Tone shift is minor, but this allows the User to adjust to a particular tone that best fits their particular preference or hearing ability.

Note: TONE adjustment is only available when operating in VCO audio type (Audio 01).

Audio Type

Press the MENU button until AUDIO is selected, then press the MENU Plus (+) or Minus (-) buttons to select either Audio 00 (PWM audio) or Audio 01 (VCO audio). The default setting is Audio 01 (VCO).

In either audio type, the *Axiom's* continuous audio responds proportionately to the target's signal strength. Large/strong signals sound loud and small/weak signals sound faint. This enhances the ability to judge a target's size, shape and depth.

In addition to enhancing target signals, the *Axiom's* proportional audio allows the operator to hear faint background noise. By their nature, high-performance pulse detectors are often noisier than VLF-type detectors; therefore, some minor audio noise/chatter is normal. An experienced operator will learn how to distinguish random background noise from repeatable target signals.

As a general rule, poor conductors such as small nuggets, specimen gold, nickels, or small bronze coins, etc. should produce a high tone followed by a low-tone echo. Good conductors such as large nuggets, copper and silver coins, etc. should produce a low tone followed by a high-tone echo. A target on the



When TONE is highlighted, use the Plus / Minus Menu buttons for Tone adjustment.



When AUDIO is highlighted, use the Plus / Minus Menu buttons for Audio type selection.



Tone and Audio Options (continued)

borderline between a poor and good conductor may fluctuate multiple times between high and low tones to indicate a borderline conductor.

It is important to understand that iron (ferrous) targets on any pulse detector can and will vary widely in their readings on the tone/conductivity scale, and is greatly affected by the iron's size, shape, orientation, and condition. Small iron is often, but not always, a high tone (i.e. just like low conductors) and large iron is often, but not always, a low tone (just like good conductors).

Audio 00 (PWM Audio)

In PWM Audio, the target's volume increases proportionally with signal strength but the audio pitch is fixed at either a high or low tone; the pitch is not proportional. Some users prefer this type of audio for its active, coarse response.

Audio 01 (VCO Audio)

In VCO Audio, the target's volume and audio pitch both increase proportionately with signal strength. Most users prefer this type of audio for its smooth response and their increased ability to perceive faint targets that produce faint changes in audio pitch.

Target Signal Strength Indicators

Detected targets are heard and shown on the *Axiom*. The upper bargraph shows signal strength and polarity. Targets with high tones will create a proportional response toward the right of center. Low-tone targets will create a proportional response toward the left of center.

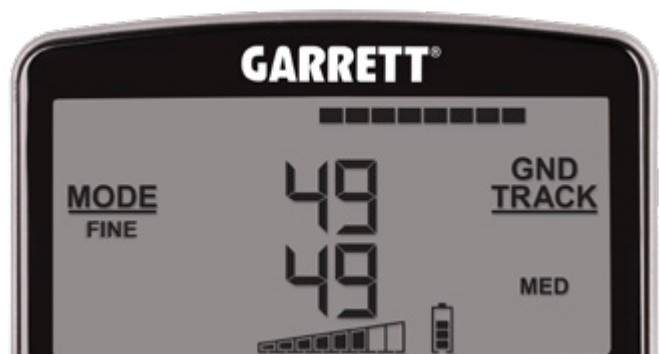

This detected target is causing the upper row of pixels to swing to the right, which corresponds with a target creating a high tone..

Backlight and Speed

Backlight

Press the MENU button until the Backlight icon is selected, then press the MENU Plus (+) or Minus (-) buttons to switch on or off the LCD backlight, for searching at night or in low-light situations.

Note: As a convenience, the backlight will automatically activate when scrolling through the menu, regardless of the backlight setting. It will return to its selected setting once the menu is exited.

Speed

This adjustment refers to the speed at which you scan the coil as well as target recovery speed, also known as Reactivity. Set the Speed adjustment according to your preferred scanning speed, target recovery speed/reactivity, and EMI noise conditions as described below.

Press the MENU button until SPEED is selected, then press MENU Plus (+) or Minus (-) buttons to choose between Slow, Medium or Fast scan speeds.

SLOW: This setting will produce the smoothest and quietest operation thereby ensuring excellent depth and sensitivity, but will require a slow coil swing and will have less ability to separate adjacent targets due to slower reactivity.

MED: This is the default setting and should be used as a general-purpose selection for moderate coil swing speed. This setting will also provide increased ability to separate adjacent targets due to its medium reactivity. You may notice an increase in EMI and noise chatter compared to the SLOW setting, but will still provide good depth and sensitivity.

FAST: This setting allows a faster coil swing to search an area more quickly and will have increased ability to separate adjacent targets due to faster reactivity, but may also increase EMI and noise chatter, making it more difficult to discern faint targets.



When Backlight icon is highlighted, use the Plus / Minus Menu buttons to switch on or off.

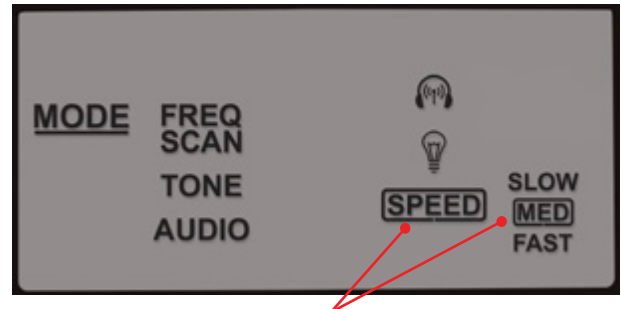

When SPEED icon is highlighted, use the Plus / Minus Menu buttons to select desired coil swing speed.



Sensitivity

Sensitivity

Use the SENS Plus (+) or Minus (-) buttons to select one of eight (8) Sensitivity levels. Default setting is 4.

Use increased sensitivity when searching for very small or very deep targets. Use lower sensitivity levels, as needed, when the detector is behaving erratically (due to excessive metallic trash, highly mineralized soils, electrical interference or the presence of other metal detectors) and the erratic operation cannot be resolved with Ground Balance or Frequency Scan.

Note: The *Axiom* is a very high-performance detector. The upper Sensitivity settings (6–8) are extremely sensitive and should only be used if environmental conditions and operator's skill level allows.

Axiom may be noisy when attempting to operate indoors or in city (urban) environments due to excessive EMI. Perform a Frequency Scan and reduce sensitivity as needed to obtain stable operation. The unit's highest sensitivity levels are designed for experienced users accustomed to operating their detectors at the very limits of marginal stability in order to obtain maximum possible performance.

It is recommended to operate at factory default sensitivity until the operator becomes experienced and accustomed to *Axiom*'s high-sensitivity operation.



Use Plus / Minus SENS buttons to select desired sensitivity.

Ground Balance Procedure and Indicators

Concentrations of ground mineralization can create erratic detector sounds (“ground noise”) and reduce performance if the mineralization is not compensated for. *Axiom* has advanced Ground Balance capabilities to handle all ground conditions—including ironstone ground and even saltwater.

Note: It is recommended to Ground Balance the *Axiom* in each new environment in order to ensure maximum stability and depth.

Note: DD coils are inherently less susceptible to ground mineralization than are mono coils, and therefore may provide better stability and performance in severely mineralized grounds.

Ground Balance Procedure

- Find an area clear of metallic objects and raise the searchcoil about 6 inches (15 cm) above the ground.
- Press and hold the GND BAL button while bouncing the searchcoil from 1 to 6 inches above the ground.
- Continue pumping the coil until the ground response is completely eliminated or becomes as small as possible, typically within a few seconds.
- Release the GND BAL button.

Ground Balance Values

The *Axiom* continually displays the current ground balance values using two independent numbers. During the Ground Balance procedure, these numbers will lock in or stabilize at the best Ground Balance values. With Ground Track set to OFF, these numbers will not change until you either Ground Balance again or engage a Ground Tracking option.

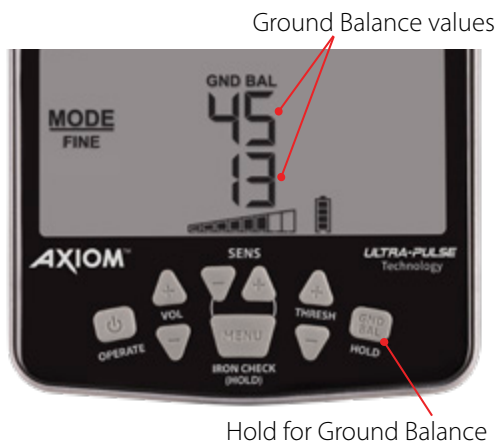

During a Ground Balance procedure, GND BAL will display on the LCD. Dual Ground Balance values are shown by the upper and lower 2-digit numbers.

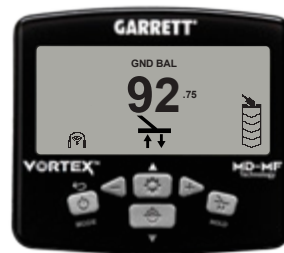

Typical GB range (Upper and Lower numbers)

Ground / Target	Typical GB range (Upper and Lower numbers)
Saltwater	Upper: 0-15 Lower: 0-20
Moist salt bed / salty soil	Upper: 0-15 Lower: 0-20
Moist salt bed / salty soil mixed with ferrous ground, some hot rocks or terra cotta	Upper: 15-45 Lower: 10-20
Typical ferrous ground without salts, most hot rocks and terra cotta	Upper: 45-55 Lower: 20-35



Ground Balance (continued)

Ground Balance Window and Hot Rocks

Axiom's unique Ground Balance Window feature helps overcome hot rocks and other localized ground variations. Hot rocks are typically highly ferrous, iron-based rocks that are either more or less conductive than the surrounding soil, thereby creating a response that can resemble a target.

Because of *Axiom's* inherent immunity to most normal soil minerals, hot rocks can typically be eliminated by simply ground balancing to the hot rock instead of the ground. But in extremely mineralized soil, the *Axiom* must be ground balanced to the soil, in which case the hot rock may produce a response.

To simultaneously eliminate the mineralized soil and a hot rock, utilize a longer Ground Balance process that activates the Ground Balance Window feature, as follows.

During the first ten seconds of ground balancing, the Ground Balance Window is always reset to zero, and is disabled. During this time, the detector will attempt

to ground balance to a single ground condition, as is the case for normal ground conditions.

However, after ten seconds of ground balancing, the operator will hear another double-beep, indicating that *Axiom* has now activated the Ground Balance Window feature to eliminate both the mineralized soil and the hot rock. Continue holding down the GND BAL button while combining a vertical pump over the soil with a horizontal scan across the hot rock in a repeating pattern as shown. Be sure to very briefly pause between the vertical pump and the horizontal scan to ensure the ground and the hot rock create distinctive signals.

Continue this pattern until the ground and hot rock responses are eliminated or become as small as possible. Then release the GND BAL button.

When ground conditions are such that you no longer need the Window feature, simply reground balance to the ground and exit within ten seconds. This will clear the Ground Balance Window, setting it back to zero.

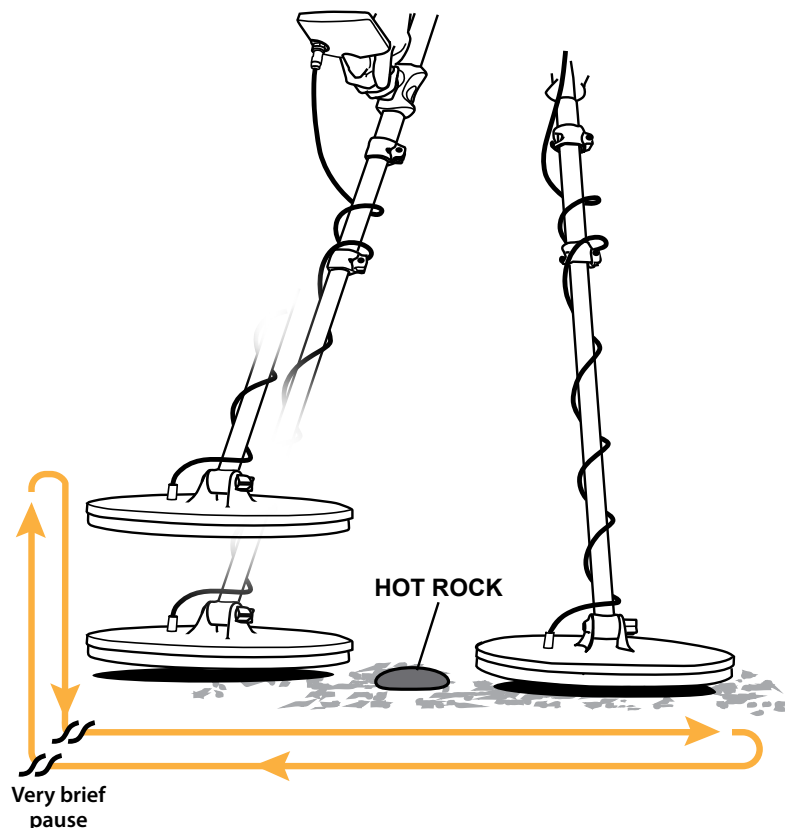

Ground Track

When switched on, Ground Track slowly tracks to changes in ground mineralization by automatically adjusting the ground balance values. However, when entering a new area, you should first perform Ground Balance to quickly obtain a good starting point.

Press the MENU button until GND TRACK is selected, then press the MENU Plus (+) or Minus (-) buttons to scroll through the four Ground Track settings: OFF, SLOW, MED and FAST.

- OFF:** Ground Tracking is not activated and the ground balance values will remain fixed at their current values. OFF is the default setting and is preferred unless tracking is needed to address frequently changing ground conditions.
- SLOW:** The ground balance values will very slowly track to slowly changing ground conditions.
- MED:** The ground balance values will track a little faster to changes in ground conditions.
- FAST:** The ground balance values will track even faster for use in quickly changing ground conditions, but this setting may also produce the greatest loss in detection depth.

Note: Ground Track may reduce detection depth due to slowly tracking to a target, especially with repeated swings over the target and when set to faster settings. Therefore, Ground Track should only be used when changing ground mineralization requires frequent re-ground balancing. Utilize only as much tracking speed as necessary to keep ground responses sufficiently suppressed. If Ground Track is ON but ground balance values remains fairly constant, this indicates ground conditions may be stable enough to switch Ground Track OFF.

Ground Trend Arrows

When Ground Track is ON, arrows will show the trending direction of the changing ground balance values.

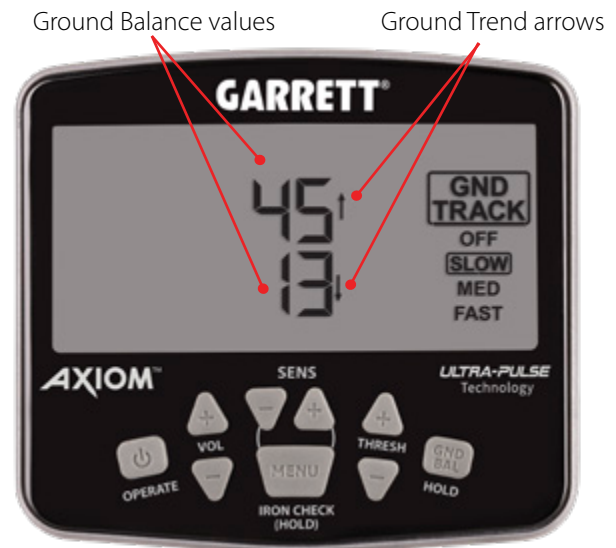

Press MENU repeatedly to reach Ground Track, then use Plus / Minus buttons to select desired setting.



Iron Check

Use this feature to audibly identify iron targets. Iron Check only works with DD searchcoils and will not work with mono coils. If the Iron Check button is pressed while using a mono coil, a repeating warning alarm will indicate this to be an invalid action.

To Utilize Iron Check:

- Move the searchcoil to the side of the target.
- Press and hold the IRON CHECK button and wait for a double-beep.
- Then continue holding the IRON CHECK button while repeatedly scanning back and forth completely past the target with very flat, level swings.
- If desired, check the target again from different directions by rotating around 90 degrees. Maintain very flat, level swings over the target.
- Iron will produce a very low-tone buzz sound that may or may not be flanked by normal tones.
- Non-ferrous and/or weak targets will produce normal tones, or may even be silent, but typically won't produce the iron tone (buzz).

Note: Iron Check is a conservative function. To help ensure *Axiom* does not misidentify a good target as iron, the iron tone (buzz) will only activate on strong signals. Therefore, small/weak iron targets may not identify as iron. In addition, due to their large, flat surface area and relatively high conductivity, steel bottle caps will typically not identify as iron.

Examples of iron targets that will produce the iron tone (buzz) are: a 3-inch nail to a depth of about 5 inches; and a ¾-inch boot nail to a depth of about 2 inches. In highly mineralized areas, Iron Check accuracy may be affected. Therefore, it is very important to use flat, level swings to improve accuracy.

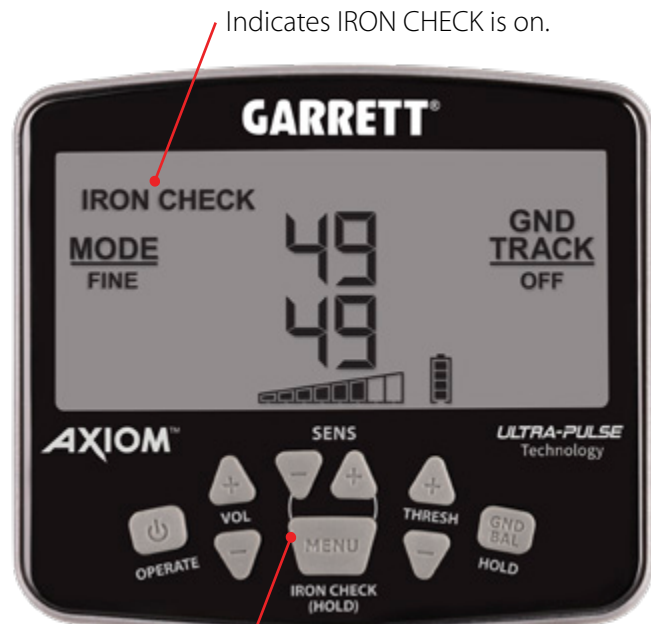

Press and hold IRON CHECK to use this function.

Detecting Techniques and Tips

If you are new to metal detecting, start searching in areas with sandy and loose soil to make it easier to learn how to use your metal detector, how to pinpoint a target, and how to recover it.

Adjust Stem Length and Coil Angle

Release lower stem clamp and fully extend until it snaps into place. Then, adjust upper stem to comfortable length and close the stem clamps. When your detector is properly adjusted, you should be able to swing the coil over the ground without stretching or stooping.

Your searchcoil should remain parallel to the ground as you sweep it. The coil's bolt should not be overtightened. When properly tightened, the coil's angle should remain stable and fixed when scanning, but loose enough so that the coil's angle can be easily adjusted by pressing against the ground.

Operating with Short Stem Length

In some scenarios, such as searching the walls of mines, you may want to collapse the Axiom to a very compressed operating length.

First, fully collapse the upper stem. Then collapse the lower stem partially, leaving at least 10 inches (25 cm) of stem exposed. This distance helps prevent the coil from detecting the stem clamp and other metal in the detector. In addition, ensure the coil angle does not move to prevent false signals.

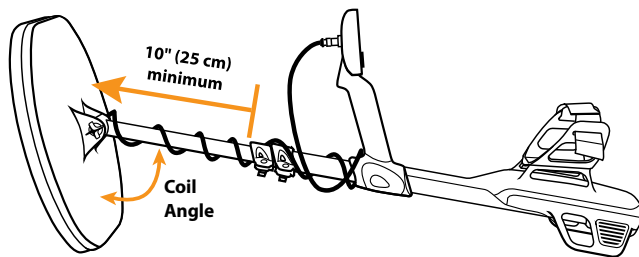

Proper Coil Swinging

Keep your searchcoil height about 1/2 inch (1.25cm) above and parallel to the ground at all times for best detection results.

Walk slowly as you scan your searchcoil in a slight arc from side to side at a speed of about 3 feet (1 meter) per second. Advance the searchcoil about half the length of the searchcoil at the end of each sweep. Avoid excessive contact with rocks.

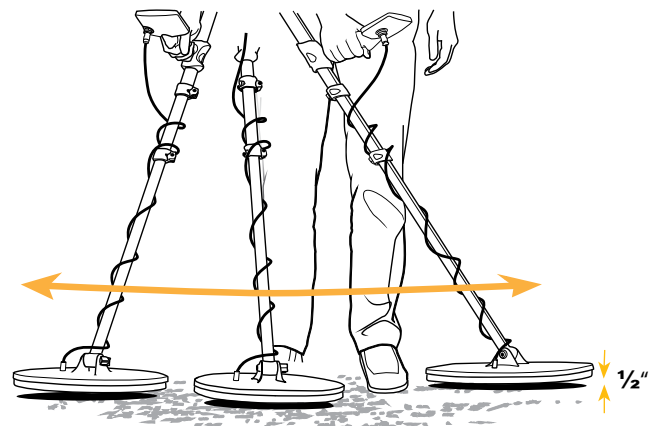

3 feet (1 m) per second at 1/2 inch (1.25 cm) above ground

Pinpointing a Target

To precisely locate a target—sweep the coil side-to-side and front-to-back in a cross-hair pattern over the target area while listening for the peak audio signal beneath the center of the coil.

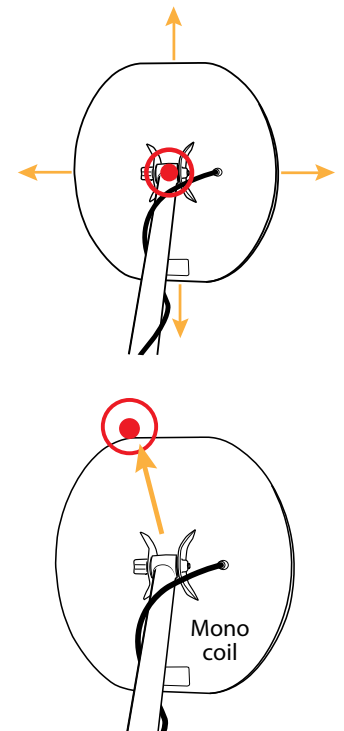

For very small, shallow targets, use either front corner of the mono coil to more precisely locate the target.



Bench Tests

You should conduct bench tests to become more familiar with the *Axiom's* signals and operation using different Modes, Speeds, and Audio Types. Suggested test items include:

- Various size gold nuggets or gold rings. Note: In the absence of gold nuggets, a U.S. nickel or small bronze coin are good imitators of the response characteristics of a similar size nugget.
- Coins or relics you expect to find in your search area.
- Various size iron targets for testing the Iron Check feature.

Note: By their nature, high performance pulse detectors, like the *Axiom*, are often very noisy indoors or anywhere near developed areas due to numerous sources of electromagnetic interference (EMI). It is therefore best to test the detector outdoors, away from common EMI sources (e.g. power lines, electrical equipment, buildings, etc.). Tests should be performed with the searchcoil completely stationary and several feet away from any large metallic object.

Basic Testing

Begin passing various metallic targets from side-to-side across the bottom of the searchcoil. Pass the targets both near and far from the coil to hear how proportional audio sounds (i.e. loud for strong signals, faint for weak signals).

Tone Polarity Test

Begin passing various metallic targets over the searchcoil to hear the response using both Audio 00 (PWM audio) and Audio 01 (VCO audio). You will notice that poor conductors (i.e. small nuggets, nickels, small bronze coins, etc.) will produce a high tone followed by a low-tone echo. Good conductors such as large nuggets, copper and silver coins, large bronze coins, etc. should produce a low tone followed by a high-tone echo.

A target on the borderline between a poor and good conductor may fluctuate multiple times between high and low tones to indicate a borderline conductor.

For pulse induction detectors, iron can and will read everywhere on the tone/conductivity scale, which is greatly affected by the iron object's size, shape, orientation, and condition. Small iron is often a high tone (just like low conductors) and large iron is often a low tone (just like good conductors), but not always.

Iron Check test

Iron Check only works when using a DD searchcoil. Press and hold the IRON CHECK button and wait for the double beep before scanning targets. Continue to hold the IRON CHECK button while quickly scanning your test targets back and forth across the coil.

Notice which iron targets produce the very low-tone growl/grunt sound and at what distances. Notice that many iron targets will create a different response when their orientation is changed. Since the *Axiom's* Iron Check function is conservative to help ensure that small/weak good signals are not misidentified as iron, small iron targets may not identify as iron.

Test both ferrous and non-ferrous targets at various depths to become familiar with Iron Check's capabilities and limitations.

Sensitivity test

Increase and decrease Sensitivity to see how detection depth and noise are affected. For example, higher Sensitivity increases depth and possibly increases noise.

General Advice

Metal Detecting Code of Ethics

The following is a Code of Ethics that many treasure hunters and clubs follow to preserve our exciting sport of metal detecting. We encourage you to do the same:

- I will respect private and public property, all historical and archaeological sites and will do no metal detecting on these lands without proper permission.
- I will keep informed on and obey all local and national legislation relating to the discovery and reporting of found treasures.
- I will aid law enforcement officials whenever possible.
- I will cause no willful damage to property of any kind, including fences, signs and buildings.
- I will always fill the holes I dig.
- I will not destroy property, buildings or the remains of deserted structures.
- I will not leave litter or other discarded junk items lying around.
- I will carry all rubbish and dug targets with me when I leave each search area.
- I will observe the Golden Rule, using good outdoor manners and conducting myself at all times in a manner which will add to the stature and public image of all people engaged in the field of metal detection.

Cautions

When searching for treasure with your Garrett detector, observe these precautions:

- Never trespass or hunt on private property without permission.
- National and state parks / monuments and military zones, etc. are absolutely off-limits.
- Avoid areas where pipelines or electric lines may be buried. If found, do not disturb and notify proper authorities.
- Use reasonable caution in digging any target, particularly if you are uncertain of the conditions.
- If you are unsure about using your metal detector in any area, always seek permission from the proper authorities.

Caring for Your Axiom

Your Garrett detector is rugged, designed for outdoor use. However, as with all electronic equipment, there are some simple ways you can care for your detector to maintain its high performance.

- Avoid extreme temperatures as much as possible, such as storing the detector in an automobile trunk during the summer or outdoors in sub-freezing weather.
- Keep your detector clean. Remove the stems and wipe them, the control housing, and the searchcoil with a damp cloth when necessary.
- *Axiom's* speaker cover can be removed to clean sand and debris from the speaker, if needed. Use the included hex wrench to remove the two screws beneath the speaker to remove the speaker cover.
- Remember that your searchcoil is submersible, but your control housing and connectors are not.
- Recharge the detector's battery at least once a year if you are not using it regularly.



Troubleshooting

SYMPTOM	SOLUTION
No power	<ol style="list-style-type: none"> 1. Ensure battery is charged. 2. Connect to charger and verify the battery icon is blinking (indicating charge is in progress).
Erratic sounds	<ol style="list-style-type: none"> 1. Ensure the coil connector is secure and the coil cable is snugly wound around the stem. 2. Perform a factory reset to clear all settings by holding down the Power button for 5 seconds. 3. If using the detector indoors, be aware that excessive amounts of electrical interference exists, plus excessive amounts of metal can be found in floors and walls. Move outdoors to test the unit in an area of ground clear of excessive metal, buried or overhead powerlines, etc. 4. Determine if erratic noise is caused by electrical interference (EMI) or something else. Hold the coil perfectly stationary on the ground away from any target. <ol style="list-style-type: none"> a. If noise continues, then it is likely caused by electrical interference (EMI): <ol style="list-style-type: none"> i. Perform Frequency Scan. ii. Reduce sensitivity, if needed. iii. Move to a different location away from EMI. b. If noise stops when coil is stationary, then it is likely due to ground or metal detection: <ol style="list-style-type: none"> i. Ensure <i>Axiom</i> is properly ground balanced. ii. Ensure no nearby or buried metal. iii. Investigate remaining responses; could be deep/faint signals that are marginally detectable. iv. Reduce sensitivity, if needed.
	<p>Intermittent signals typically mean you have found a deeply buried target or one that is positioned at a difficult angle for your detector to read. Scan from different directions to help define the signal, and/or scrape away some soil to get the coil closer to the target.</p>
Responds when bumping coil against rocks, etc.	Use a coil cover to cushion the coil's impact with items such as rocks, trees, etc.

Caution:
Always power OFF your Axiom before changing searchcoils. Disconnecting and reconnecting coils while the detector is powered on could damage the searchcoil and/or the detector's electronics.



Warranty Information

Your *Axiom* is warranted for 36 months, limited parts and labor, but does not cover damage caused by alteration, modification, neglect, accident or misuse.

In the event you encounter problems with your *Axiom* detector, please read through this User's Manual carefully to ensure the detector is not inoperable due to manual adjustments. Press and hold the power button for 5 seconds to return to the recommended factory settings.

You should also make certain you have:

1. Checked your battery charge and connections. A low battery is the most common cause of detector "failure."

2. Contacted your dealer for help, particularly if you are not familiar with the *Axiom* detector.

In the event that repairs or warranty service are necessary for your *Axiom*, contact the retail outlet where your detector was purchased. To avoid excessive shipping and import charges, do not attempt to return a Garrett product to the factory in the United States.

Information on international warranty/repair needs can be found on the Garrett website: **www.garrett.com**. Click on the Sport Division and then the Warranty/Support menu for more details.

Regulatory Information

This device complies with part 15 of the FCC Rules. Operation is subject to the following two conditions: (1) This device may not cause harmful interference, and (2) this device must accept any interference received, including interference that may cause undesired operation.

Changes or modifications not expressly approved by the party responsible for compliance could void the user's authority to operate the equipment.

This device complies with Industry Canada license-exempt RSS standard(s). Operation is subject to the following two conditions: (1) this device may not cause interference, and (2) this device must accept any interference, including interference that may cause undesired operation of the device.

Ce produit est conforme aux normes RSS exemptes de licence d'Industry Canada. Son fonctionnement est soumis aux deux conditions suivantes : (1) ce dispositif ne peut pas provoquer d'interférences et (2) ce dispositif doit accepter toute interférence, y compris celles pouvant entraîner un dysfonctionnement.

Wireless Transmitter Specifications

Audio Delay:	17 milliseconds
Audio Bandwidth:	30-18,000 Hz
Operating Frequency:	2406-2474 MHz
Transmit Power:	5.6 dBm EIRP
Certifications:	FCC, CE, IC, AS/NZ



Axiom Specifications

Ultra Pulse™ Technology	✓
Pulse Rate	1500 Hz (adjustable)
Frequency Scan	Automatic EMI cancellation
Z-Lynk™ Wireless (integrated)	✓
Backlight	✓
Ground Balance	Automatic, dual channel
Ground Balance Readings	Dual independent numbers
Ground Balance Window™	✓
Ground Track Modes	OFF, Slow, Medium, Fast
Iron Check™	✓
Volume Control	✓
Threshold Control	✓
Tone Control	✓
Audio Type Adjustment	Audio 00 (PWM audio) or Audio 01 (VCO audio)
Sensitivity/ Depth Adjustments	8
Water/Weather Resistance	✓
• Waterproof coil/stem	✓
• Rainproof control box	✓
Available Searchcoils	11" x 7" mono coil 11" x 7" DD coil 13" x 11" mono coil 13" x 11" DD coil 16" x 14" mono coil 16" x 14" DD coil
Length (Adjustable)	Fully extended: 61.5" (156 cm) collapses to 25" (63.5 cm)
Total Weight	4.2 lbs. (1.9 kg) with 11" mono coil and coil cover 4.7 lbs. (2.1 kg) with 13" mono coil and coil cover
Battery Source	Rechargeable Lithium Ion, built-in; 76 Wh, 306 g
Battery Condition Indicator	✓
Warranty	3 Years, Limited Parts/Labor